

2

THULE[®]
SWEDEN

Instructions

Thule Xscape for bedrail

500050



Bring your life
thule.com

EN

Important - Read the instructions carefully before use and keep for future reference.

Symbols



WARNING indicates a hazardous situation which, if not avoided, could result in death or serious injury.



CAUTION indicates a hazardous situation which, if not avoided, could result in minor or moderate injury.



NOTE indicates additional information that is useful for trouble-free and optimal use of the product.

ES

Importante - Leer las instrucciones cuidadosamente antes del usar y consérvelas para futura referencia.

Símbolos



ADVERTENCIA indica una situación de posible peligro que, si no se evita, podría provocar lesiones graves o incluso la muerte.



ATENCIÓN indica una situación peligrosa que, si no se evita, podría provocar lesiones leves o moderadas.



NOTA indica información adicional que es útil para un uso óptimo y sin problemas del producto.

FR

Important - Lisez attentivement les instructions avant utilisation et conservez-les pour référence future.

Symboles



AVERTISSEMENT indique une situation potentiellement dangereuse qui, si elle n'est pas évitée, pourrait provoquer des blessures graves, voire mortelles.



ATTENTION indique une situation potentiellement dangereuse susceptible qui, si elle n'est pas évitée, peut entraîner des blessures mineures ou modérées.



REMARQUE indique comment répondre à une situation donnée et vous donnent des conseils sur le fonctionnement des options disponibles.

PT

Importante - Ler cuidadosamente as instruções antes de usar e guardá-las para futura referência.

Símbolos



ATENÇÃO indica uma situação perigosa que, se não for evitada, pode resultar em morte ou ferimentos graves.



CUIDADO indica uma situação perigosa que, se não for evitada, pode resultar em ferimentos ligeiros ou moderados.



NOTA indica informações adicionais que são úteis para a utilização ideal e sem problemas do produto.

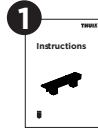

+

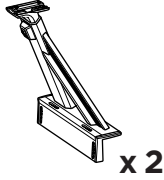
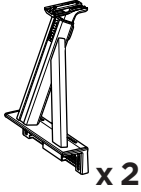
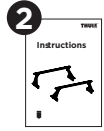

x2



x2



x4



x4



x4

i

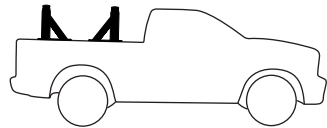
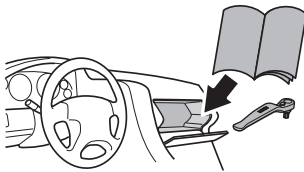

+



+



+



=

Max 227 kg / 500 Lbs



+

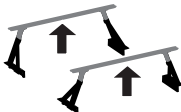

+



+



=

Max 136 kg / 300 Lbs



EN

When mounting the Thule Xscape system on a vehicle truck bed rail or tonneau cover, it is the responsibility of the driver of the vehicle to review and adhere to the owner's manual of the vehicle or tonneau cover manufacturer's maximum permissible load from the loading surface.

ES

Al montar el sistema Thule Xscape en el rail de la plataforma de una camioneta o en la cubierta del tonneau, es responsabilidad del conductor del vehículo revisar y cumplir con el manual del propietario del vehículo o con la carga máxima permitida por el fabricante de la cubierta del tonneau desde la superficie de carga.

FR

Lors du montage du système Thule Xscape sur un rail de la plateforme du camion ou une bâche, il en va de la responsabilité du conducteur du véhicule de consulter et de se conformer au manuel du véhicule du propriétaire ou au chargement admissible maximal du fabricant de la bâche depuis la surface de chargement.

PT

Ao montar o sistema Thule Xscape no trilho da caçamba ou capota marítima de um veículo, é responsabilidade do motorista do veículo revisar e respeitar as instruções do manual do proprietário do veículo ou a carga máxima permitida pelo fabricante da capota marítima.

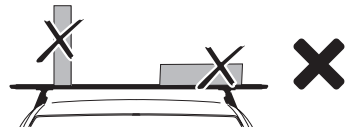
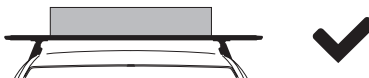
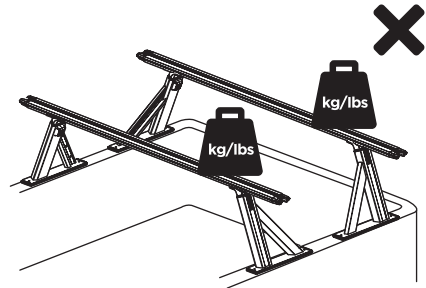
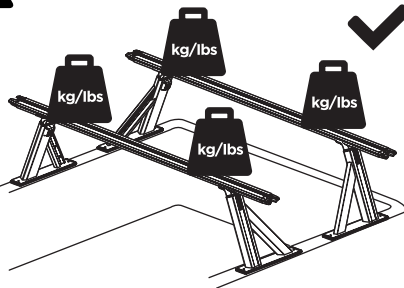
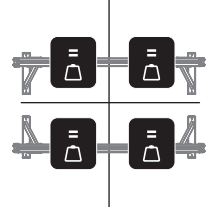
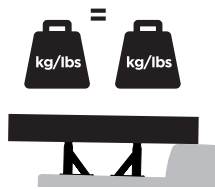
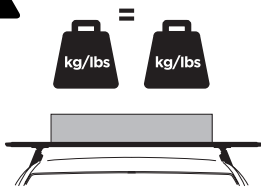

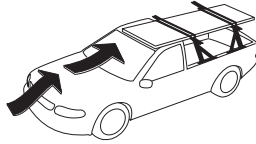
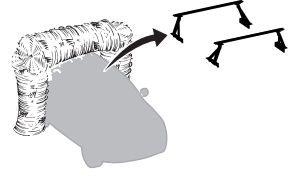
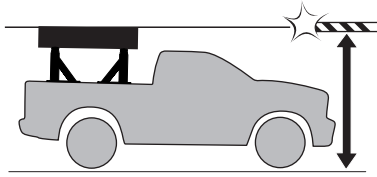
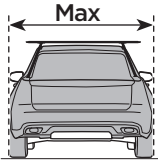

80 km/h
50 Mph

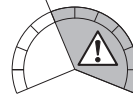

500 km/310 Miles

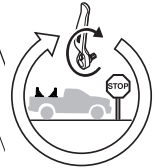
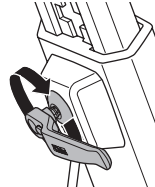
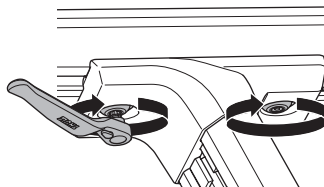

1



+



1

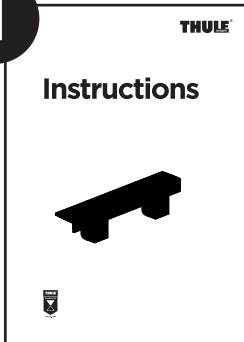

1

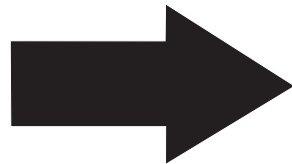

2



+



+

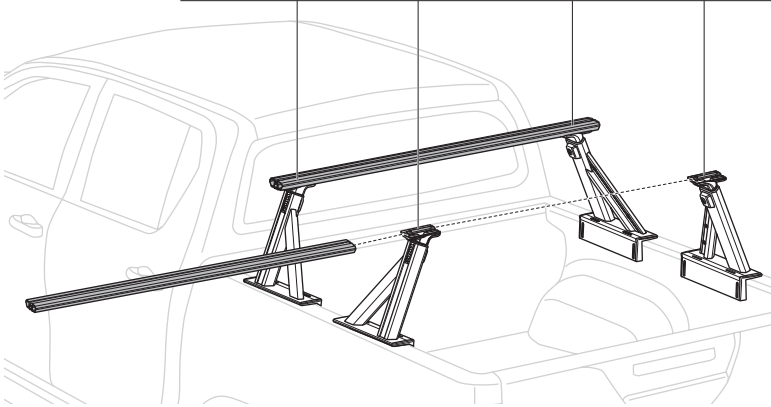
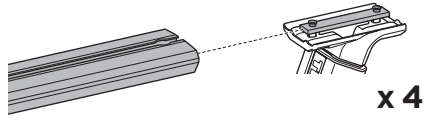

3

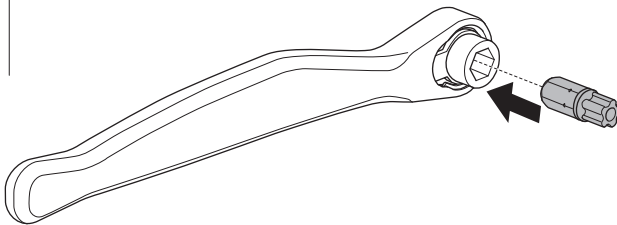

4

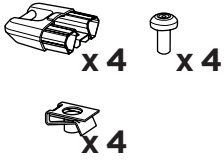

A

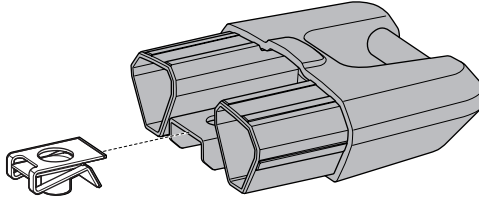

B

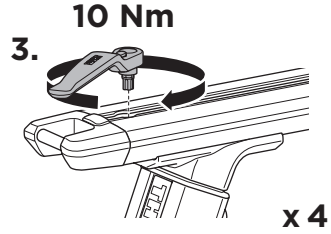
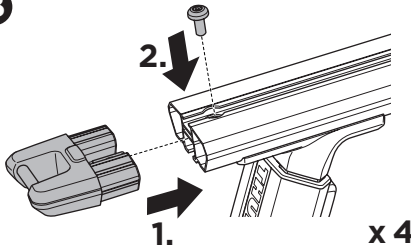

i

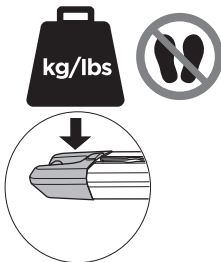

5



A

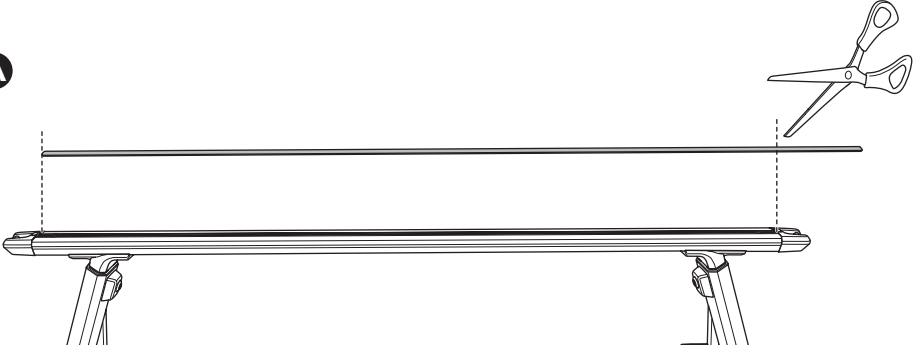

B

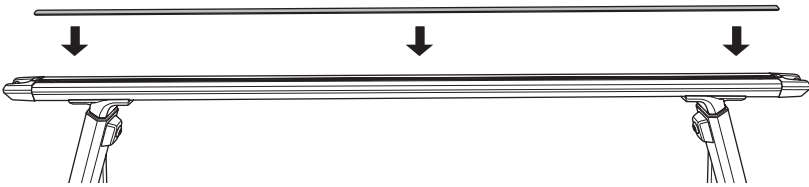

C

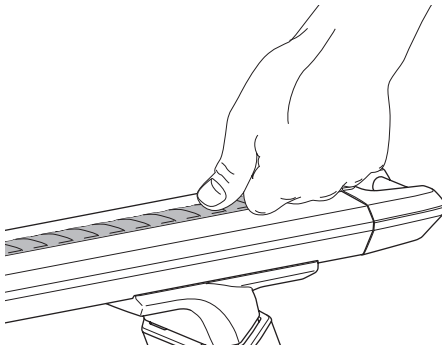

6

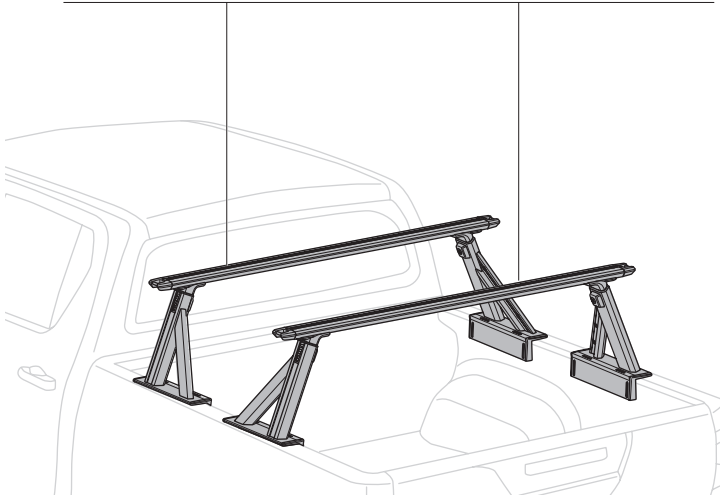
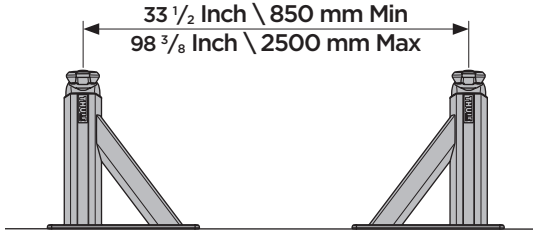

1

THULE

> Instructions



5





7

1

THULE

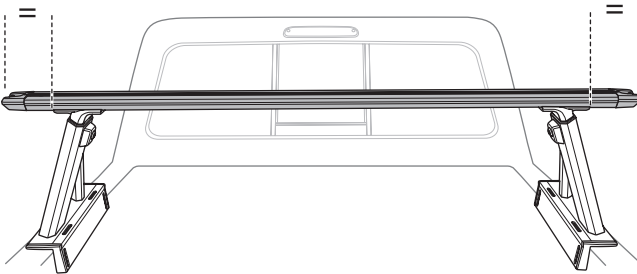
> Instructions



5



i

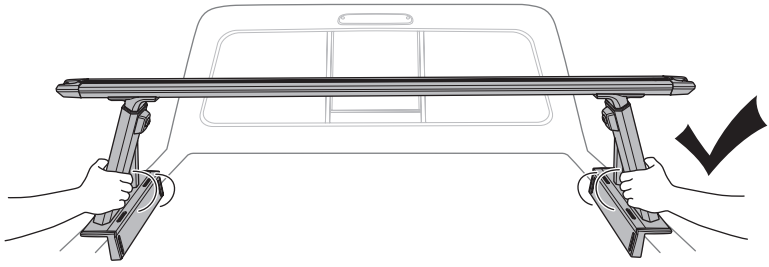

x 2

8

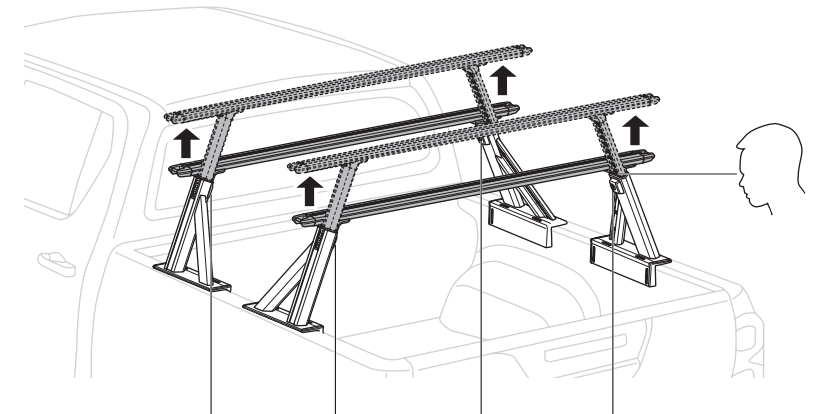

A

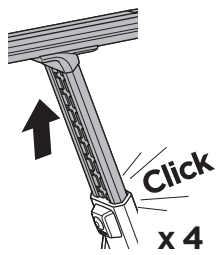

B

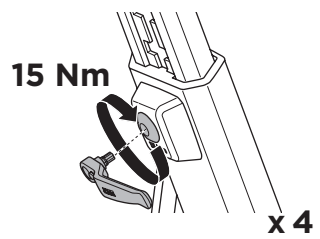

9

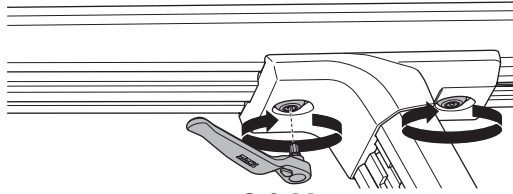
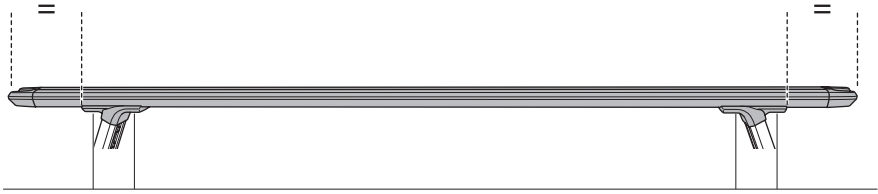

24 Nm

x 8

i

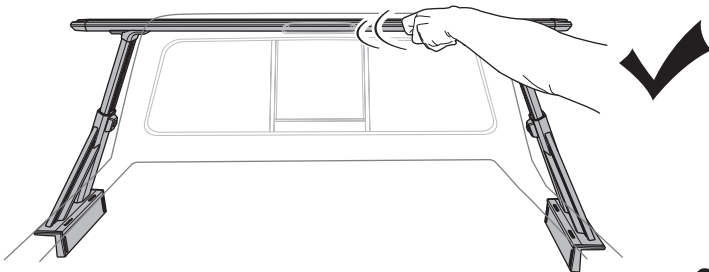

x 2

i

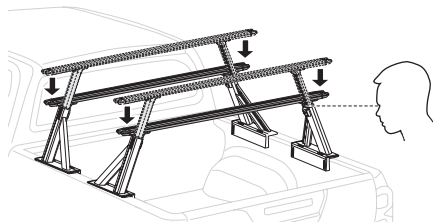

A

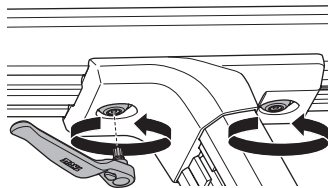

x 8

B

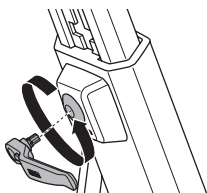

x 4

C

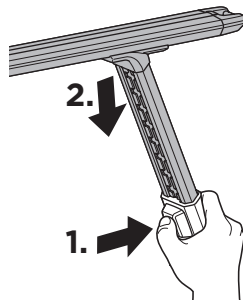

x 4

D

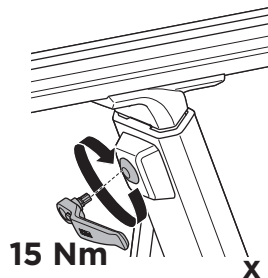
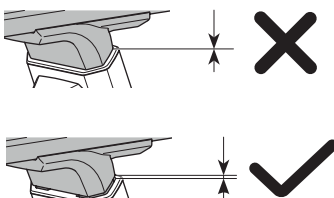
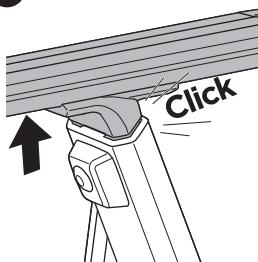

15 Nm

x 4

E

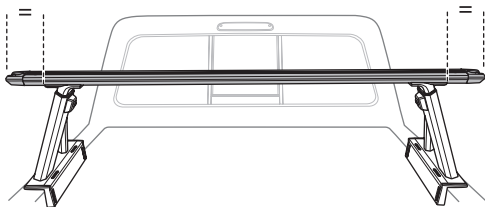

x 2

F

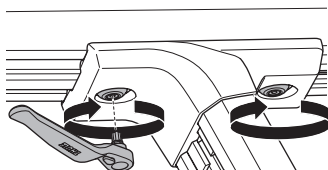

24 Nm

x 8