

MALONE®

ATTENTION CUSTOMERS

Thank you for your recent purchase of a Malone trailer.

Please inspect all parts and hardware bags prior to assembly.

****Set the large red envelope (in the axle box) containing important documents in a safe spot.**

If you encounter damage of any packaging or parts, or find that parts are missing - please email us with photos and your Proof of Purchase at:

Email: technical@maloneautoracks.com

**Business Hours: Monday-Friday
9am- 5pm**

Thank you from all of us at Malone



MPG585

CHANGING THE WAY YOU GET THERE

MALONE

CHANGING THE WAY YOU GET THERE

Important Note

Product Warranty & Registration Form

All information is confidential and used exclusively by MALONE only.

Dear Customer,

Thank you for your purchase of a Malone Product.

In order to be eligible for the Malone Warranty program, we ask that you contact us by email or online at one of the following: With-in 30 days of purchase. You can also mail this letter back to the address at the bottom.

- Online: www.maloneautoracks.com
- Email: Technical@maloneautoracks.com

We will require the information below.

Here is the information collected:

First Name: _____

Last Name: _____

Address: _____

Address2: _____

City: _____

State: _____

Zip: _____

Country: _____

Email: _____

Phone: _____

Product Description/Name: _____

Product MPG# _____

Date Purchased: _____

Store Where Purchased: _____

Purchase Price: _____

Thank you for choosing Malone!

MALONE AUTO RACKS 81 County Rd. Ste 1, Westbrook, ME 04092
P: 207.774.9100 F: 207.615.0551
E: technical@maloneautoracks.com W: www.maloneautoracks.com

MALONE®

MPG585

CHANGING THE WAY YOU GET THERE

Malone EcoLight™ Trailer

Model MPG585 Assembly Instructions



Take a few moments and read through these instructions to familiarize yourself with the step by step assembly process before you begin turning wrenches.

Unpack and sort the components into groups as shown in the following pages.

Then assemble each group in order. Lets get started !!

Required Tools:

- (2) 3/4" wrenches • (2) 9/16" wrenches (a deep socket is recommended)
- Large flat blade screw driver • 7/16" wrench • 3/8" wrench and socket
- 13/16" socket • Large Phillips head screw driver • Rubber hammer

MALONE AUTO RACKS 81 County Rd. Ste 1, Westbrook, ME 04092

P: 207.774.9100 F: 207.615.0551

E: technical@maloneautoracks.com W: www.maloneautoracks.com

MPG585

Group 1: Frame Components

Bag 11439

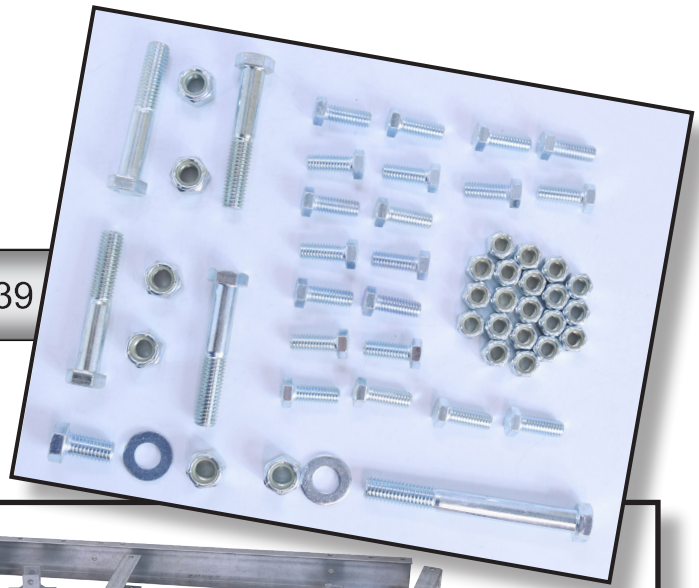

Group 2: Axle / Spring Components

Bag 11432



**Visit www.maloneautoracks.com/Replacement-Parts
for all of your spare part needs**

Group 3: Lighting Components



Group 4: Fender Components

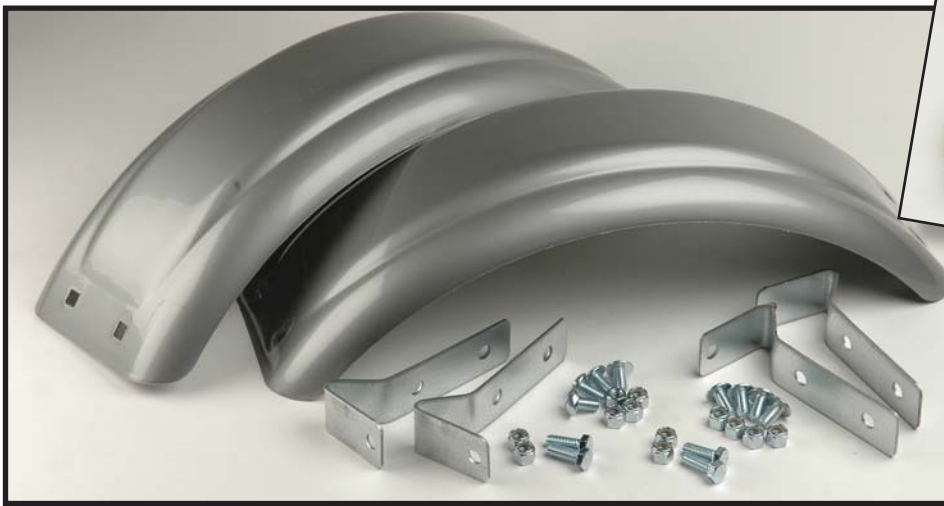

Bag 11431

Group 5: Coupler Components



Bag 11494

**Visit www.maloneautoracks.com/Replacement-Parts
for all of your spare part needs**

Group 6: Load Bar Components

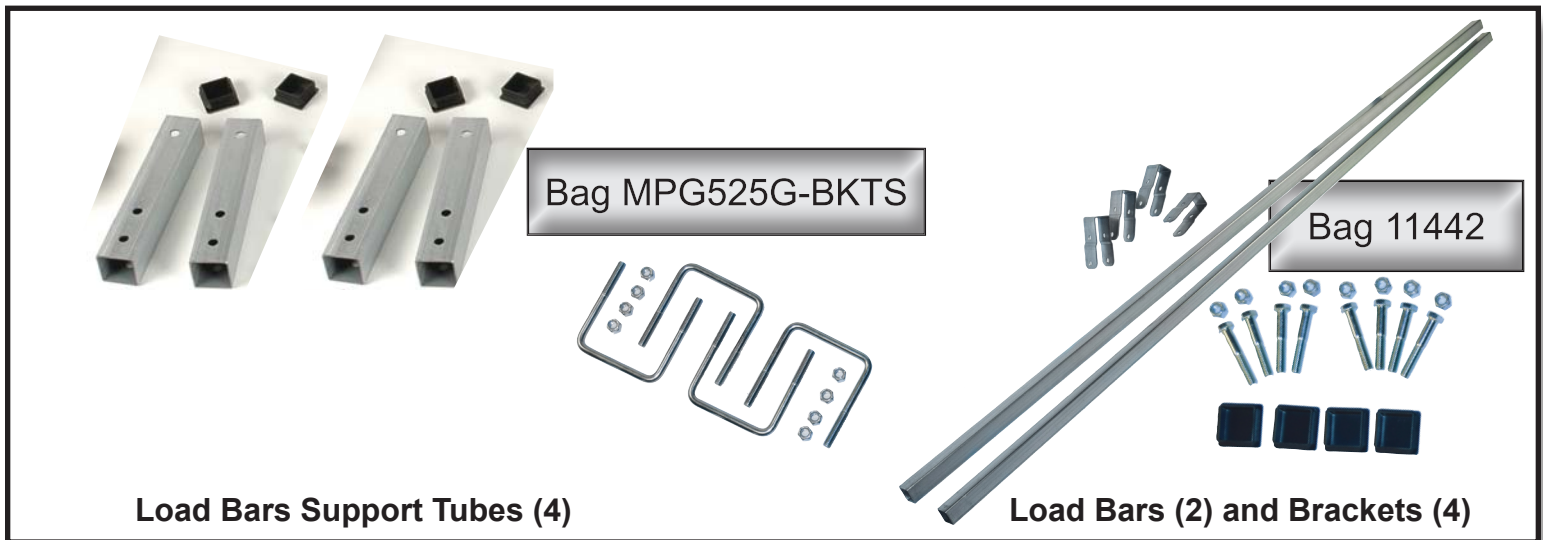

TONGUE & FRAME ASSEMBLY (Group 1)

1. First we will build the 2 piece tongue. The middle of the tongue has symmetrical holes for the joining plates. The forward end of the tongue has holes for the coupler.

2. Stand the front tongue section on end with the coupler holes up. Push the wire protection grommet into the wiring harness hole as shown. See image 1.

3. Get the wiring harness out of the light kit. Unkink the wiring harness and pass the entire harness through the grommet and out the opposite end of the tongue.

TIP: Tie a loose knot in the wiring about 18" from the plug. This lead will be used to connect to the vehicle. See image 2.

4. Align the 2 tongues half's together and pass the wiring harness through, and out the rear of the second piece. See image 3.

5. Being careful not to pinch the wiring harness, square the tongue half ends together and install the joining plates on each side. (NOTE: the rear tongue section is symmetrical so it works fine either way. It has no top or bottom.) Fully tighten the 1/2" bolts with two 3/4" wrenches. See image 4.

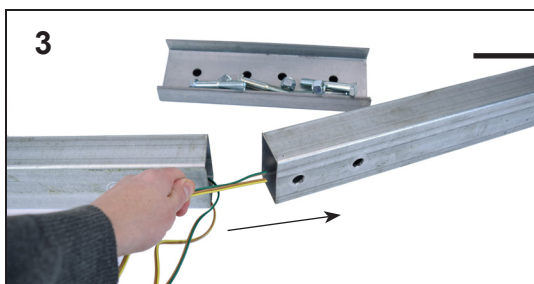
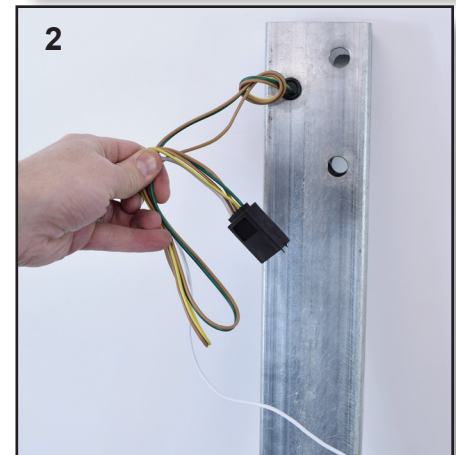
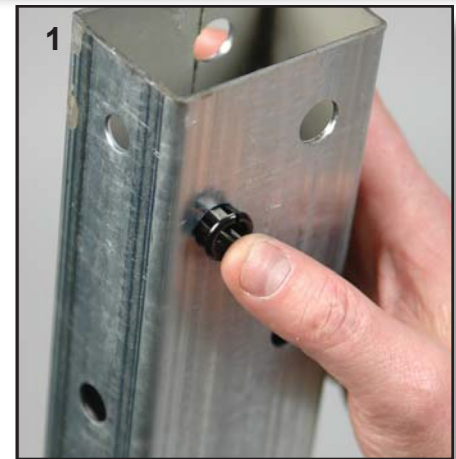

Visit www.maloneautoracks.com/Replacement-Parts

for all of your spare part needs

technical@maloneautoracks.com
800-295-0042 ext. 215

NOTE: We start the assembly of the Main frame first, right side up.

6. Aline all the cross members as shown. See image 5.

NOTE: Direction of middle cross member faces rearward.

7. Install the bolts downward from the top and secure with nylon lock nut. **Hand Tighten Only.** Measuring from the rear corners diagonally to the front corners will insure your frame is square (@ 58 3/4"). Adjust as needed and **fully secure** the 4 corners. See image 6.

8. We now flip the main frame **on its back** to make it easier to install the tongue, springs and axle. See image 7.

Once the springs and axle assembly is installed we will flip the trailer over to complete the assembly.

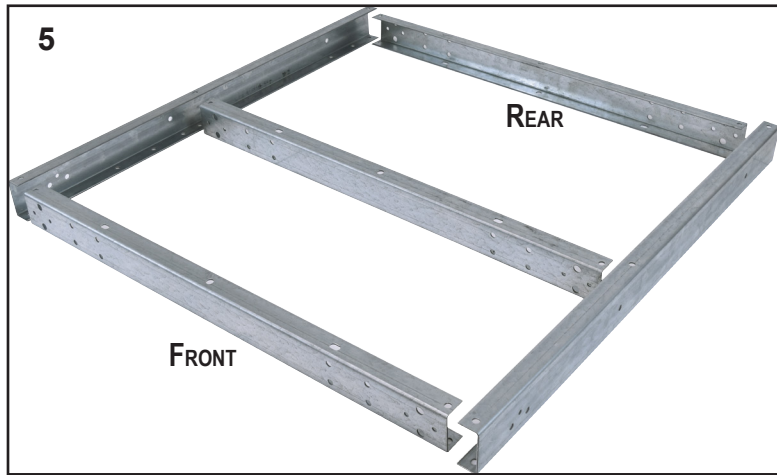

9. With the frame components upside down as shown install the remaining hardware for the cross members, fully tighten the four corners first, again measuring to insure the frame is square. Fully tighten the rear spring hangers and finger tighten the front spring hangers. See image 7.

10. Lay the tongue onto the frame, with the MALONE logo upside down. Support the end of the tongue so it lays nearly flat on the cross members. See image 8.

11. Install the long 1/2" bolt down through the tongue and front cross member, (washer under the bolt head), nut inside the cross member and fully tighten. Install the short 1/2" bolt inside the end of the tongue, (washer under the bolt head), nut inside the cross member and fully tighten. See image 8.

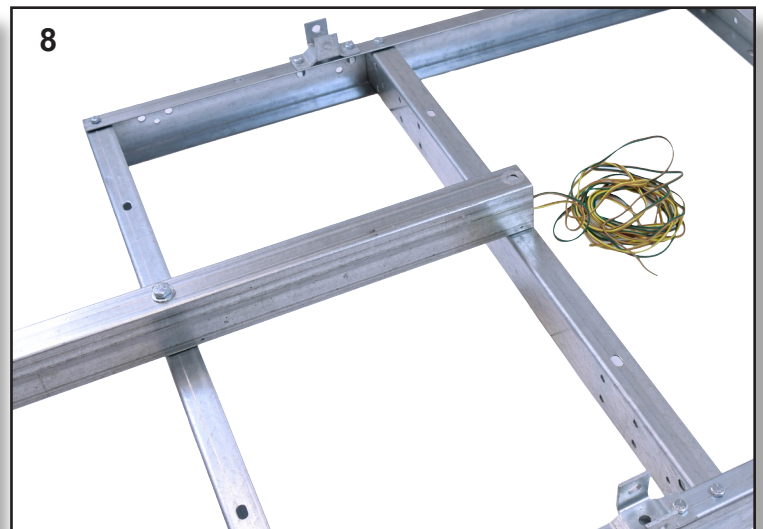
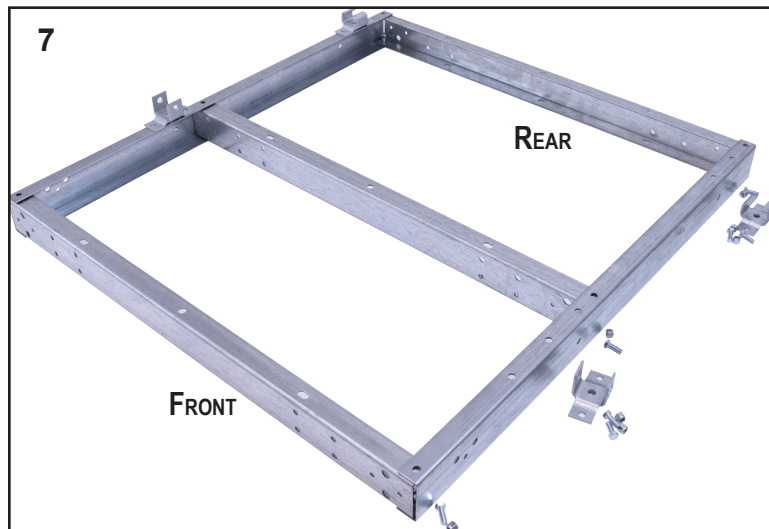

SPRING & AXLE ASSEMBLY (Group 2)

1. Set the large red envelope (in the axle box) containing important documents in a safe spot.
2. Spin the axle to find the side with the spring centering holes. These holes mate with the spring center stud.

3. Lay the springs on top the axle with the centering studs in the holes in the axle. Then assemble the U-bolts, tie plates and nuts as shown. **Make sure both springs are facing the same way!**

4. Run each nut down **UNTIL IT TOUCHES THE PLATE ONLY! DON'T TIGHTEN!!**

You will need to wiggle the springs to fit them into the spring brackets in the next step.

5. Lift the axle/spring assembly to the trailer frame and slide the slipper spring ends into the slipper spring brackets. Then let the spring eyes down into the front hangers

6. Install the shackle bolts with the nuts to the inside and tighten until firm. Do not over tighten which would bend the spring hanger in and pinch the spring.

7. Fully tighten the 4 front spring hanger mounting bolts.

8. Fully and evenly tighten the 8 axle U-bolts.

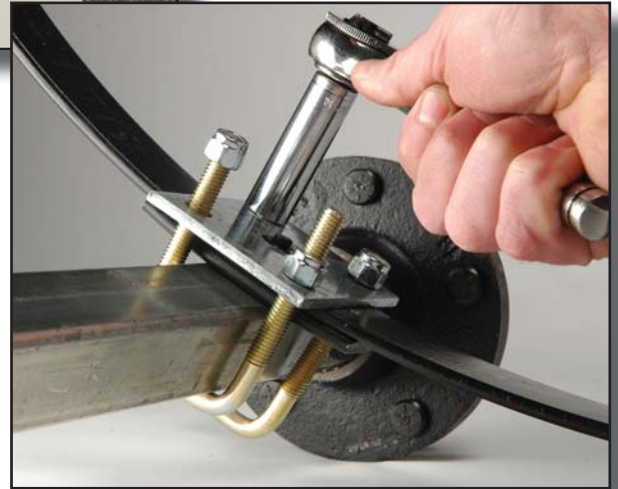
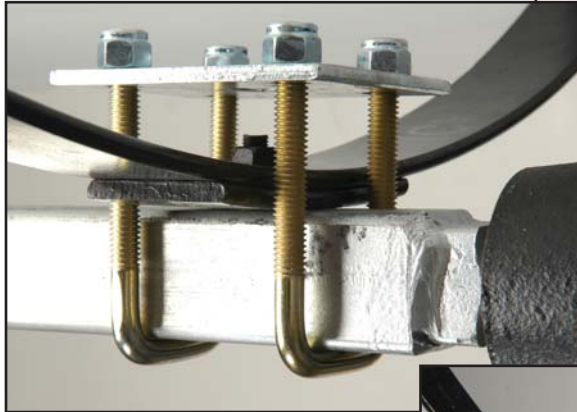
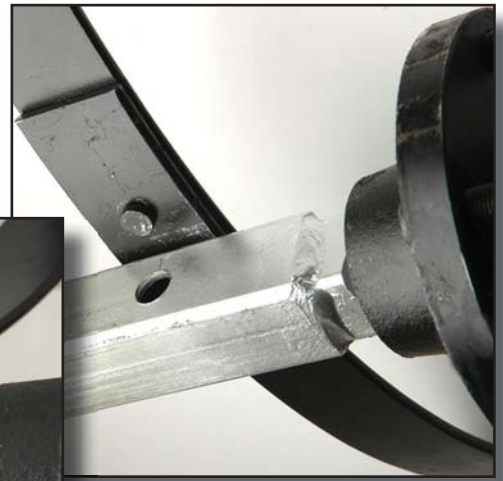

NOTE: images are for reference only and may not reflect your items/parts specifically.

9. Install the wheels on the hubs with the valve stems facing out and install and finger tighten the lug nuts.

10. Lift the trailer at one rear corner and roll it over onto the tires.

ALWAYS BEND FROM YOUR KNEES WHEN LIFTING. IF THE TRAILER IS TOO HEAVY FOR YOU TO FLIP SAFELY RECRUIT SOME FRIENDS TO ASSIST YOU.

11. Tighten the lug nuts firmly to 75 to 85 foot pounds of torque.



LIGHT ASSEMBLY (Group 3)

REFERENCE:

Trailer Wiring Color Code

- Brown = running lights
- Yellow = driver turn / driver brake
- Green = passenger turn / passenger brake
- White = ground

Before passing the wires through the frame, install the plastic grommets in both the rear (2) frame cross member as well as the middle cross member (2) as pictured.

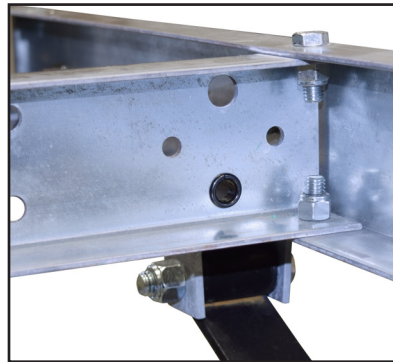

Middle Cross Member



Rear Cross Member

1. Pass the lead wires from the tail light through the grommet. Then sandwich the license plate mounting bracket between the driver side lamp and the frame. Use the nuts provided with the lamp kit to secure tail light. See image 1.

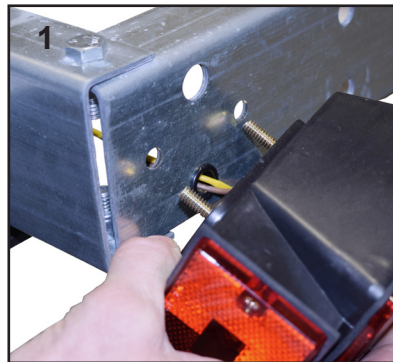

2. Install side marker lights at the 3 holes in the front of the side rails, center hole for the bolt, lower hole for the wire. Use the nuts provided with the lamp kit to secure the light. See image 2.

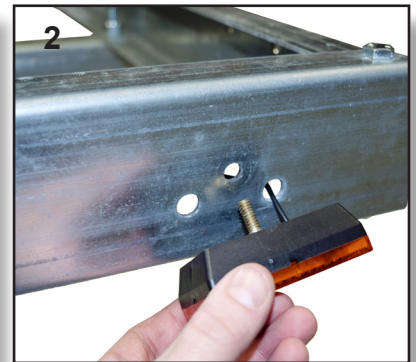

3. Check that the wiring harness outside the tongue grommet at the coupler is still full length and did not pull into the tongue.

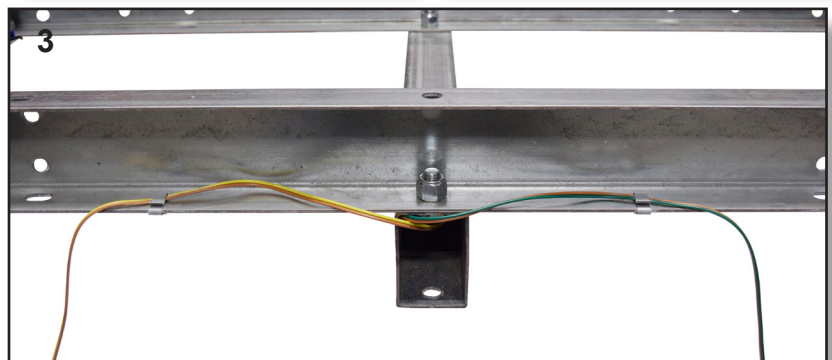

4. At the rear of the tongue, Install wire clips beside the tongue and Route the GREEN/ BROWN wire along the passenger's side of the frame. Route the YELLOW/BROWN wire along the driver's side. See image 3.

5. Pass the wiring through the grommet in the middle cross member and bring it towards the side marker lights. **Note: We will connect to the side markers first and then bring the wiring back to the tail lights.**

6. Mark where you will connect the side marker wire. Lift the harness on top of the frame. Pierce the knife tip between the wires, PULL only about 1/2" of wire past the blade, then use your fingers to pull 2-3 inches of wire apart.

7. Press the brown wire into the quick connector as shown. Then insert the wire from the side marker light fully into the 2nd opening. Use pliers to squeeze the conductor blade down and through the insulation. The blade cuts through the insulation and connects the wires inside. Flip the cover to lock the connector. Repeat on the other side again using the brown wire.

8. Install wire clips on frame rail, secure wires and now pass the loose end of the wires back through the middle cross member and grommet to connect to the tail lights.

9. Using your fingers, separate about 1" of the ends of the harness. Strip about 3/8" of insulation off each wire to allow length for wrapping around the stiff tail light wire.

10. Hold the color matching harness and tail light wires together with the end of the stripped insulation even with each other, then wrap the harness wire clockwise around the tail lamp wire completely covering it.

11. Screw a wire nut down over each until firm. Secure wires to frame with wire clip.

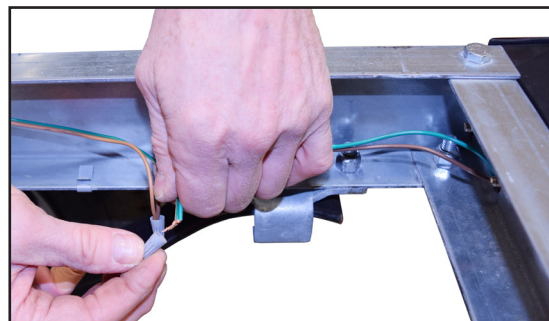
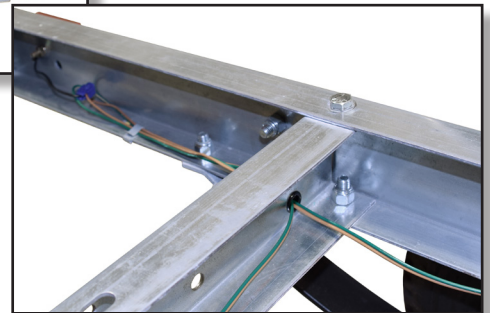
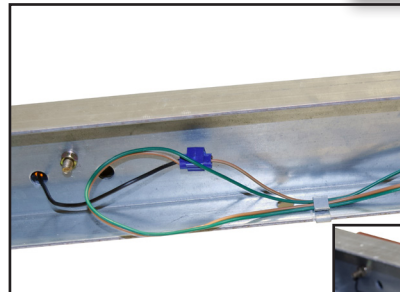
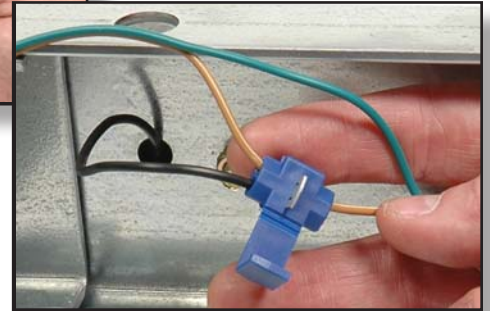
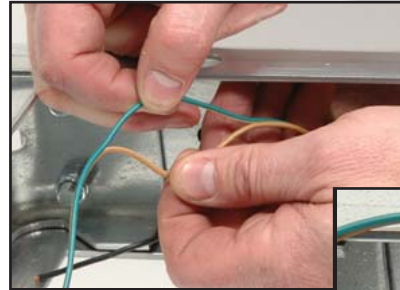
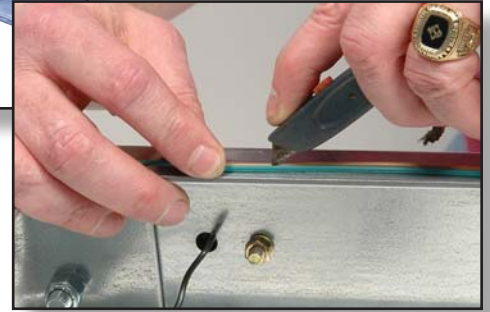
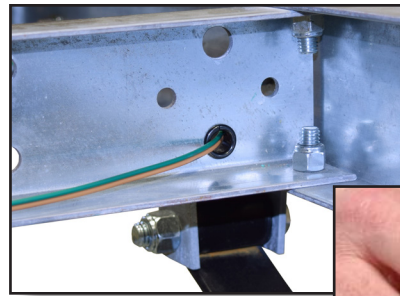

FENDER ASSEMBLY (Group 4)

1. Loosely install fender mounting brackets as shown so they can move to fit the fender. Use hex bolts with the nuts inside the frame.

2. Install and fully tighten fender. Use screws and nuts, nuts inside fender.

3. Fully tighten fender mounting brackets.



COUPLER ASSEMBLY (Group 5)

1. Installing the ground wire ring connector. Strip 3/8" of insulation off the white ground wire and crimp on the ring connector as shown.

2. Assemble the tongue skid to the safety chains with a 3/8" x 1-1/2" bolt as shown. Use washers above and below the chain ends.

3. Place the skid and chain assembly under the tongue and insert the bolt up through the skid bolt hole on the bottom of the tongue.

4. Slip the ring terminal over the bolt and install the nylon lock nut finger tight.

5. Check that the rear end of the skid is in its hole on the bottom of the tongue. Tighten the BOLT while holding the nut stationary. This way the ring terminal remains straight.

6. Install the coupler and coupler handle onto the tongue as shown. Then tighten until the coupler firmly grips the tongue. Don't over tighten and crush the tongue.

NOTE: OVER TIGHTENING WILL PREVENT THE COUPLER LATCH FROM FUNCTIONING PROPERLY.

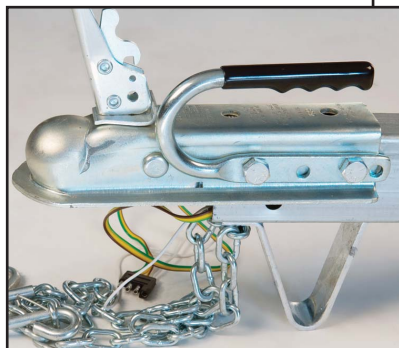

LOAD BAR ASSEMBLY (Group 6)

1. Use a small hammer or block of wood to install the end plugs into the top end of all four load bar support tubes.
2. Place load bar support tube in the rear corner of the frame as shown and mount it with the large U-bolt going around the frame rail and through the load bar support tube. Repeat for remaining 3 support tubes, one in each corner.
3. Secure fully with the nylon lock nuts. Repeat for the remaining 3 support tubes.

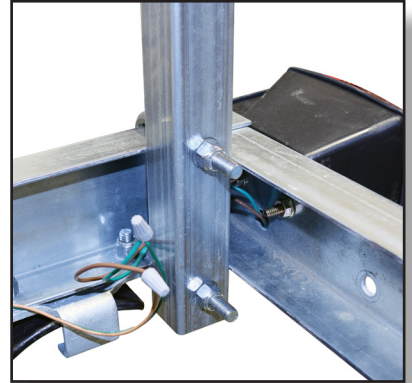
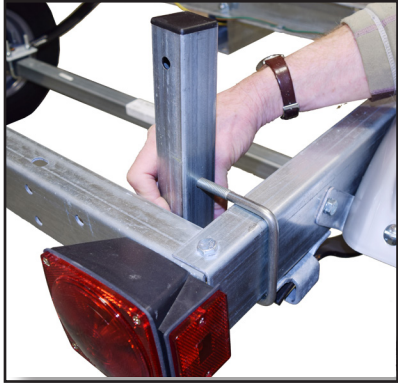

4. Slip the load bar brackets over the load bars (as shown) and loosely install the two small bolts / nuts through each bracket trapping the load bars inside the brackets.

- 5). Install and hand tighten the bolts holding each bracket to the support tube.

- 6). Center the load bars to the trailer, then tighten all 8 bracket bolts.

- 7). Complete the cross bars with the new end caps.



PLEASE REFERENCE YOUR RED ENVELOPE

WHEN YOU RECEIVE YOUR TIRE LOADING DECAL, please apply as shown on the drivers side of the frame or tongue. Be sure to clean the frame before applying the decal.

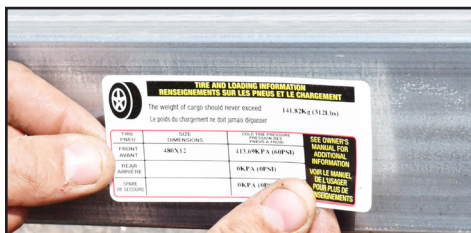

Your Malone EcoLight™ Trailer is now complete and ready to register and title! Contact your local DMV office for specific procedures in your State.



MALONE

CHANGING THE WAY YOU GET THERE

Limited Five Year Warranty

The Malone Auto Racks (Malone) Limited Five Year Warranty covers certain Malone-brand products that have been specifically identified for inclusion in the program and is effective for five years from the date of purchase for the original retail purchaser. This warranty is terminated after five years from the date of purchase, or, when the original retail purchaser sells or otherwise transfers the product to any other person or entity during the five year warranty period.

Subject to the limitations and exclusions described in this warranty, Malone will remedy defects in materials and/or workmanship by repairing or replacing, at its option, a defective product without charge for parts or labor. Malone may elect, at its option, not to repair or replace a defective product but rather issue to the original retail purchaser a refund equal to the purchase price paid for the product, or credit to be used toward the purchase of a replacement Malone product.

This warranty does not cover, and no warranty is given for defects or problems caused by normal wear and tear which includes but is not limited to surface (aesthetic) metal corrosion, scratches, dents, deformities, accidents, unlawful vehicle operation, or any modification of a product not performed or authorized in writing by Malone.

In addition, this warranty does not cover problems resulting from conditions beyond Malone's control including, but not limited to, theft, misuse, overloading, or failure to assemble, mount or use the product in accordance with Malone's written instructions or guidelines included with the product available to the original retail purchaser.

No warranty is given for Malone products purchased outside of the United States, Canada and Mexico.

If the product is believed to be defective, the original retail purchaser should contact the Malone dealer from whom it was purchased, who will give the original retail purchaser instructions on how to proceed. If the original retail purchaser is unable to contact the Malone dealer, or the dealer is not able to remedy the defect, the original retail purchaser should contact Malone by email at technical@maloneautoracks.com.

In the event that the product must be returned to Malone, a technician at the email address above will provide the original purchaser with return shipping instructions. The original purchaser will be responsible for the cost of mailing the product to Malone. In order to receive any remedy under this warranty, a copy of the original purchase receipt, a description of the defect and a return address must be provided.

Disclaimer of Liability

Repair or replacement of a defective product, or the issue of a refund or credit (as determined by Malone) is the original retail purchaser's exclusive remedy under this warranty. Damage to original purchaser's vehicle, cargo, or property, and/or to any other person or property is not covered by this warranty.

This warranty is expressly made in lieu of any and all other warranties, express or implied, including the warranties of merchantability and fitness for a particular purpose.

Malone's sole liability is limited to the remedy set forth above. In no event will Malone be liable for any direct, indirect, consequential, incidental, special, exemplary, or punitive damages, or, for any other damages of any kind or nature (including but not limited to, lost profits, lost income or lost sales).

Some states do not allow the exclusion or limitation of incidental or consequential damages, so the above limitations may not be applicable. This warranty gives you specific legal rights and you may also have other rights which vary from state to state.

In addition, all vehicular transports are potentially hazardous. Any person using MALONE products are personally responsible for following the given directions for use, installation and accepts full responsibility for any and all damages or injury of any kind including death, which may result from their use.

MALONE AUTO RACKS 81 County Rd. Ste 1, Westbrook, ME 04092
P: 207.774.9100 F: 207.615.0551
E: technical@maloneautoracks.com W: www.maloneautoracks.com